

Operating Instructions

TM1-TS / TM1-NTS

06/08 Revision 1

Ref: TS4

Contents Page

Display Symbols Explained	2
Understanding the Modes	3
Selecting the Mode	4
5/2 Day / 7 Day Programming	6
Switching Time Override	8
Countdown Timer Programming	9
Locking the Keypad	9
Holiday	10
Clean Screen	10
Factory Reset	11
Optional Feature Setup	12-14
Wiring Diagrams	15-17

Display Symbols Explained





Symbol	Description
ON OFF	ON / OFF <i>Shown to indicate whether the timed output is On or Off</i>
	Keylock Icon <i>Shown when the keypad is locked</i>

Understanding the Modes

The TM1-TS has three modes of operation.



- 5/2 Day Time-clock
(Provides 4 On/Off switching times for the weekday and 4 On/Off switching times for the weekend)
- 7 Day Time-clock
(Provides 4 On/Off switching times for each day of the week)
- Countdown Timer
(Allows you to enable the output for a countdown period)

Selecting the Mode

- Press PROG and select Setup.
- At the top of the screen you will see   and the number 06. Use the Up arrow and you will see 12.
- In the centre of the screen, use the   to set the desired mode.
- **00** = 5/2 Day **01** = 7 Day **02** = Countdown timer.
- Press Done to store and exit.

Setting The Clock

To set the clock in your thermostat, follow the steps below:

- With the thermostat turned on, press PROG.
- Press Clock.
- Use   to set the correct Time.
- Press Day to set the correct Day.
- Press Done to accept and store.





5/2 Day / 7 Day Programmable Mode

The following switching times are programmed already, however you can change them easily.

Weekday	On Time	Off Time
Wake	07.00	09.00
Leave	16.00	20.00
Return	--.---	--.---
Sleep	--.---	--.---

Weekend	Time	Temp
Wake	07.00	09.00
Leave	16.00	20.00
Return	--.---	--.---
Sleep	--.---	--.---

Changing the Switching Times

- Press PROG.
- Select Time 1.
- You will see TIME 1 and ON flash.
- Use   to set the on time for the 1st switching time.
- Press Off and then use   to set the off switching time.
- You should now repeat for the Times 2-4.
- Press Day to select the next day. In 5/2 day mode the TM1 will highlight “Sat Sun” prompting you to program the switching times for the weekend. In 7 day mode, the TM1 will highlight Tuesday.
- When complete, press Done to Store and Exit.

Switching Time Override

The TM1-TS has an override function allowing you to override the output into the opposite state.



- Press Hold.
- If the output is already On – press Off.
- If the output is already Off – press On.

You will then see the output status change and the output indication will flash to show it has been overridden from the programmed setting. The output will remain in the override state until the next programmed time. To cancel, repeat the steps above.

Timeclock Off

To turn the timeclock off completely, press and hold the Off button. The display and output will be turned off. To turn the timeclock back on, press the On button.

Count Down Timer Mode

- Use   to select the Countdown time.
- Press Done.

The output will be active until the Countdown time expires and the hold duration will display the time left.

To cancel the Countdown early, repeat the steps above reducing the time to 00.00.

Locking the Keypad

The TM1-TS has a keylock facility. To enable this press the bottom right corner of the display and hold for 10 seconds.

When activated, you will see .

To cancel, repeat the steps above.

Holiday

(5/2 Day / 7 Day Programmable Mode Only)

The Holiday function turns the output off for the number of days programmed. During the holiday, the TM1-TS will indicate the number of holiday days left.

Assume you program a holiday on Monday for 1 day, the holiday will start immediately, but the TM1-TS will count the next day (Tuesday) as the holiday. The TM1-TS will then revert back to its program at midnight Tuesday.

- Press HOLIDAY.
- Enter the duration of your holiday.
- Press Done.
- To cancel a Holiday, reduce the Holiday time to 00 days.

Clean Screen

Pressing Clean Screen will disable all buttons, allowing you 30 seconds to wipe the screen clean.

Factory Reset

The TM1-TS has a factory reset function. This will reset all settings back to their factory default.

To perform a factory reset, follow these steps:

Turn off the TMS-TS by pressing the off button. Press and hold the bottom left corner of the LCD for 10s. You will see all the icons appear for 2 seconds and then disappear. The TM1-TS has then been reset to the factory defaults.

**THE FOLLOWING SETTINGS ARE OPTIONAL
AND IN MOST CASES NEED NOT BE ADJUSTED**

Optional Features Explained





Feature 06 Communication Address (TM1-NTS Only):

This setting is used when you have connected your TM1-NTS to a network system. Each device on the network must have a unique communication address. This can be set from 01-32.

Feature 12 – Mode Select: This function allows you to select between 5/2 Mode, 7 Day mode or Countdown timer.

Adjusting the Optional Settings

To adjust the settings, follow these steps:

- With the thermostat turned on.
- Press PROG.
- Press SETUP.
- Use the   at the top of the screen to select the feature number (shown on page 14) and then use the   keys in the centre to adjust the setting.
- Press Done to accept and Store.

Feature Table

Feature	Description	Setting
06	Comms #	Enter number 01-32
12	Mode Select	00-02

Heatmiser TM1-TS Model

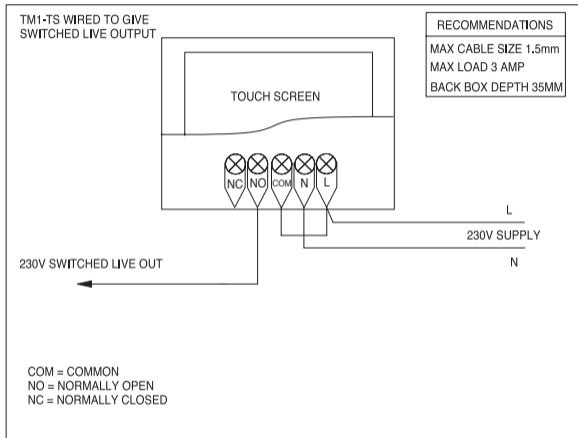

Heatmiser TM1-TS Model

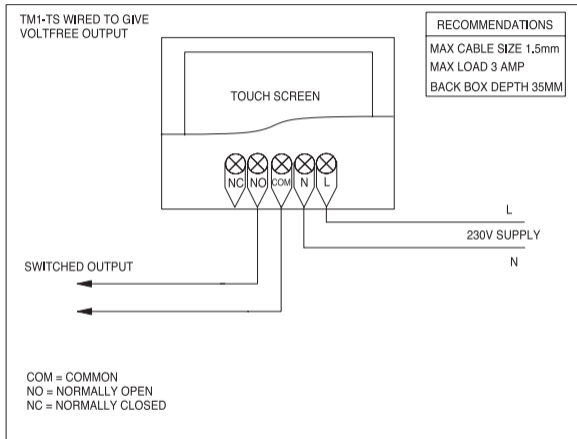

Heatmiser TM1-NTS Model

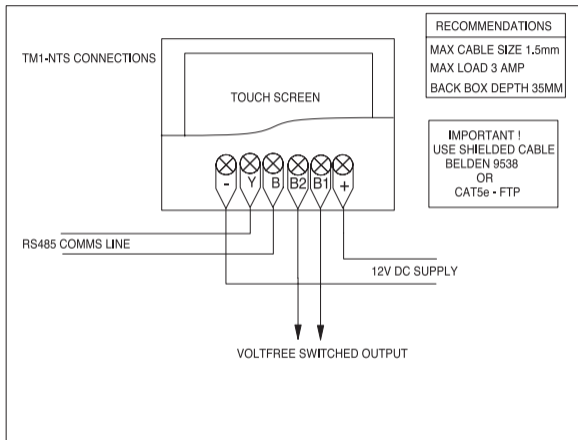

Support Tel: 01254 870303